

# 4-Mbit (512K x 8) MoBL<sup>®</sup> Static RAM

## Features

- Temperature Ranges
  - Industrial: -40°C to 85°C
  - Automotive-A: -40°C to 85°C
- Very high speed: 55 ns
  - Wide voltage range: 2.20V – 3.60V
- Pin-compatible with CY62148CV25, CY62148CV30 and CY62148CV33
- Ultra low active power
  - Typical active current: 1.5 mA @ f = 1 MHz
  - Typical active current: 8 mA @ f = f<sub>max</sub>(55-ns speed)
- Ultra low standby power
- Easy memory expansion with  $\overline{CE}$ , and  $\overline{OE}$  features
- Automatic power-down when deselected
- CMOS for optimum speed/power
- Available in Pb-free and non Pb-free 36-ball VFBGA, Pb-free 32-pin TSOPII and 32-pin SOIC packages

## Functional Description<sup>[1]</sup>

The CY62148DV30 is a high-performance CMOS static RAM organized as 512K words by 8 bits. This device features advanced circuit design to provide ultra-low active current. This is ideal for providing More Battery Life™ (MoBL<sup>®</sup>) in portable applications such as cellular telephones. The device also has an automatic power-down feature that significantly reduces power consumption. The device can be put into standby mode reducing power consumption when deselected ( $\overline{CE}$  HIGH). The eight input and output pins (IO<sub>0</sub> through IO<sub>7</sub>) are placed in a high-impedance state when:

- Deselected ( $\overline{CE}$  HIGH)
- Outputs are disabled ( $\overline{OE}$  HIGH)
- When the write operation is active ( $\overline{CE}$  LOW and  $\overline{WE}$  LOW)

Write to the device by taking Chip Enable ( $\overline{CE}$ ) and Write Enable ( $\overline{WE}$ ) inputs LOW. Data on the eight IO pins (IO<sub>0</sub> through IO<sub>7</sub>) is then written into the location specified on the address pins (A<sub>0</sub> through A<sub>18</sub>).

Read from the device by taking Chip Enable ( $\overline{CE}$ ) and Output Enable ( $\overline{OE}$ ) LOW while forcing Write Enable ( $\overline{WE}$ ) HIGH. Under these conditions, the contents of the memory location specified by the address pins will appear on the IO pins.

## Logic Block Diagram

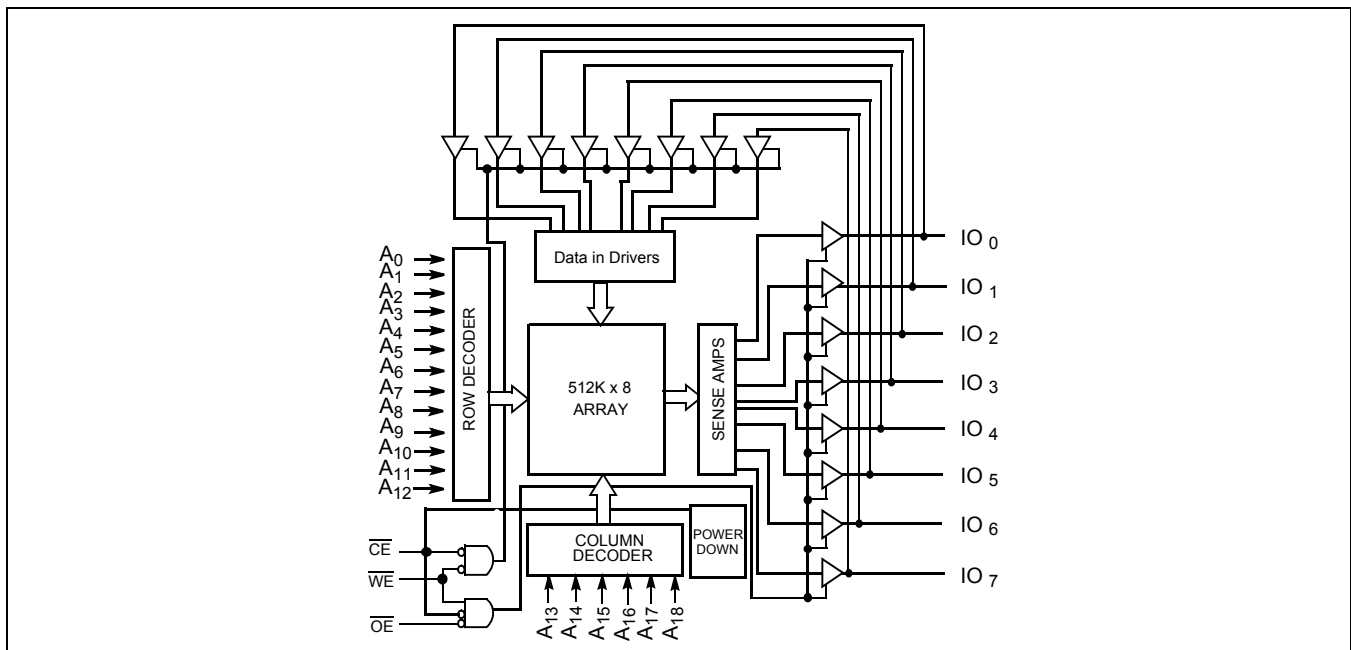

### Note:

1. For best practice recommendations, refer to the Cypress application note "System Design Guidelines" on <http://www.cypress.com>.

**Pin Configuration<sup>[2, 3]</sup>**

**36-ball VFBGA Pinout**  
Top View

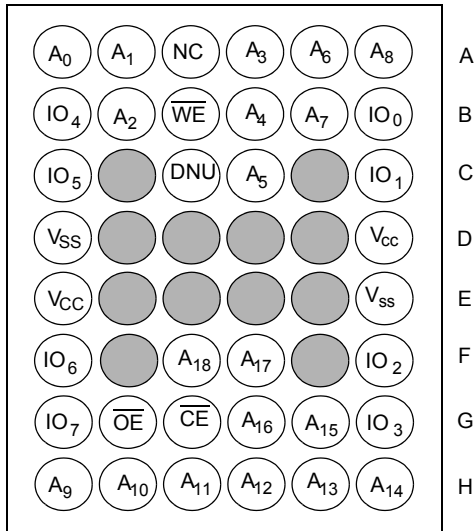

**32-pin SOIC / TSOP II Pinout**  
Top View

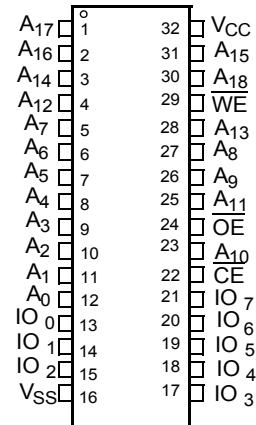

**Product Portfolio**

Product	Range	V <sub>CC</sub> Range (V)			Speed (ns)	Power Dissipation					
						Operating I <sub>CC</sub> (mA)				Standby I <sub>SB2</sub> (μA)	
		Min	Typ <sup>[4]</sup>	Max		f = 1 MHz		f = f <sub>max</sub>			
						Typ <sup>[4]</sup>	Max	Typ <sup>[4]</sup>	Max	Typ <sup>[4]</sup>	Max
CY62148DV30L	Industrial	2.2	3.0	3.6	55	1.5	3	8	15	2	12
CY62148DV30LL	Industrial				55	1.5	3	8	10	2	8
CY62148DV30LL	Industrial				70	1.5	3	8	10	2	8
CY62148DV30LL	Automotive-A				70	1.5	3	8	10	2	8

**Notes:**

- NC pins are not connected on the die.
- DNU pins have to be left floating or tied to V<sub>SS</sub> to ensure proper application.
- Typical values are included for reference only and are not guaranteed or tested. Typical values are measured at V<sub>CC</sub> = V<sub>CC(typ)</sub>, T<sub>A</sub> = 25°C.

### Maximum Ratings

(Exceeding maximum ratings may impair the useful life of the device. For user guidelines, not tested.)

Storage Temperature .....	-65°C to +150°C
Ambient Temperature with Power Applied .....	55°C to +125°C
Supply Voltage to Ground Potential .....	-0.3V to $V_{CC(max)} + 0.3V$
DC Voltage Applied to Outputs in High-Z State <sup>[5, 6]</sup> .....	-0.3V to $V_{CC(max)} + 0.3V$
DC Input Voltage <sup>[5, 6]</sup> .....	-0.3V to $V_{CC(max)} + 0.3V$

Output Current into Outputs (LOW) .....	20 mA
Static Discharge Voltage .....	> 2001V (per MIL-STD-883, Method 3015)
Latch-up Current .....	> 200 mA

### Operating Range

Product	Range	Ambient Temperature	$V_{CC}^{[7]}$
CY62148DV30L	Industrial	-40°C to +85°C	2.2V to 3.6V
CY62148DV30LL			
CY62148DV30LL	Automotive-A	-40°C to +85°C	

### Electrical Characteristics Over the Operating Range

Parameter	Description	Test Conditions		55 ns			70 ns			Unit	
				Min	Typ <sup>[4]</sup>	Max	Min	Typ <sup>[4]</sup>	Max		
V <sub>OH</sub>	Output HIGH Voltage	I <sub>OH</sub> = -0.1 mA	V <sub>CC</sub> = 2.20V	2.0			2.0			V	
		I <sub>OH</sub> = -1.0 mA	V <sub>CC</sub> = 2.70V	2.4			2.4			V	
V <sub>OL</sub>	Output LOW Voltage	I <sub>OL</sub> = 0.1 mA	V <sub>CC</sub> = 2.20V			0.4			0.4	V	
		I <sub>OL</sub> = 2.1 mA	V <sub>CC</sub> = 2.70V			0.4			0.4	V	
V <sub>IH</sub>	Input HIGH Voltage	V <sub>CC</sub> = 2.2V to 2.7V		1.8		V <sub>CC</sub> +0.3V	1.8		V <sub>CC</sub> +0.3V	V	
		V <sub>CC</sub> = 2.7V to 3.6V		2.2		V <sub>CC</sub> +0.3V	2.2		V <sub>CC</sub> +0.3V	V	
V <sub>IL</sub>	Input LOW Voltage	V <sub>CC</sub> = 2.2V to 2.7V		-0.3		0.6	-0.3		0.6	V	
		V <sub>CC</sub> = 2.7V to 3.6V		-0.3		0.8	-0.3		0.8	V	
I <sub>IX</sub>	Input Leakage Current	GND ≤ V <sub>I</sub> ≤ V <sub>CC</sub>		-1		+1	-1		+1	μA	
I <sub>OZ</sub>	Output Leakage Current	GND ≤ V <sub>O</sub> ≤ V <sub>CC</sub> , Output Disabled		-1		+1	-1		+1	μA	
I <sub>CC</sub>	V <sub>CC</sub> Operating Supply Current	f = f <sub>max</sub> = 1/t <sub>RC</sub>	V <sub>CC</sub> = V <sub>CC(max)</sub> I <sub>OUT</sub> = 0 mA CMOS levels	Ind'l	L	8	15				mA
				Ind'l	LL	8	10		8	10	mA
				Auto-A	LL				8	10	mA
		f = 1 MHz	Ind'l	L	1.5	3				mA	
			Ind'l	LL	1.5	3		1.5	3	mA	
			Auto-A	LL				1.5	3	mA	
I <sub>SB1</sub>	Automatic CE Power-down Current — CMOS Inputs	CE ≥ V <sub>CC</sub> -0.2V, V <sub>IN</sub> ≥ V <sub>CC</sub> -0.2V, V <sub>IN</sub> ≤ 0.2V f = f <sub>max</sub> (Address and Data Only), f = 0 (OE, and WE), V <sub>CC</sub> =3.60V		Ind'l	L	2	12				μA
				Ind'l	LL	2	8		2	8	
				Auto-A	LL				2	8	
I <sub>SB2</sub>	Automatic CE Power-down Current — CMOS Inputs	CE ≥ V <sub>CC</sub> - 0.2V, V <sub>IN</sub> ≥ V <sub>CC</sub> - 0.2V or V <sub>IN</sub> ≤ 0.2V, f = 0, V <sub>CC</sub> = 3.60V		Ind'l	L	2	12				μA
				Ind'l	LL	2	8		2	8	
				Auto-A	LL				2	8	

**Notes:**

5. V<sub>IL(min)</sub> = -2.0V for pulse durations less than 20 ns.
6. V<sub>IH(max)</sub> = V<sub>CC</sub>+0.75V for pulse durations less than 20 ns.
7. Full device AC operation assumes a 100 μs ramp time from 0 to V<sub>CC(min)</sub> and 200 μs wait time after V<sub>CC</sub> stabilization.

**Capacitance** (for all packages)<sup>[8]</sup>

Parameter	Description	Test Conditions	Max	Unit
C <sub>IN</sub>	Input Capacitance	T <sub>A</sub> = 25°C, f = 1 MHz, V <sub>CC</sub> = V <sub>CC(typ)</sub>	10	pF
C <sub>OUT</sub>	Output Capacitance		10	pF

**Thermal Resistance**

Parameter	Description	Test Conditions	VFBGA	TSOP II	SOIC	Unit
θ <sub>JA</sub>	Thermal Resistance (Junction to Ambient)	Still Air, soldered on a 3 x 4.5 inch, four-layer printed circuit board	72	75.13	55	°C/W
θ <sub>JC</sub>	Thermal Resistance (Junction to Case)		8.86	8.95	22	°C/W

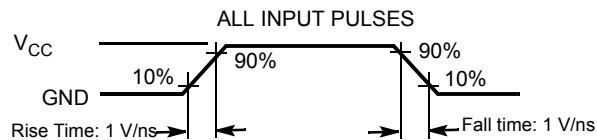
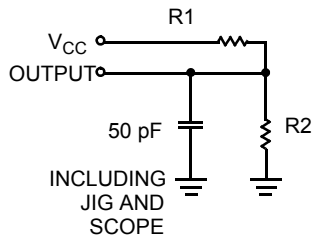
**AC Test Loads and Waveforms**

Equivalent to: THÉVENIN EQUIVALENT

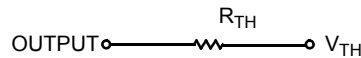

Parameters	2.5V (2.2V – 2.7V)	3.0V (2.7V – 3.6V)	Unit
R1	16667	1103	Ω
R2	15385	1554	Ω
R <sub>TH</sub>	8000	645	Ω
V <sub>TH</sub>	1.20	1.75	V

**Data Retention Characteristics** (Over the Operating Range)

Parameter	Description	Conditions	Min	Typ <sup>[4]</sup>	Max	Unit
V <sub>DR</sub>	V <sub>CC</sub> for Data Retention		1.5			V
I <sub>CCDR</sub>	Data Retention Current	V <sub>CC</sub> = 1.5V, $\overline{CE} \geq V_{CC} - 0.2V$ , V <sub>IN</sub> ≥ V <sub>CC</sub> - 0.2V or V <sub>IN</sub> ≤ 0.2V			9	μA
		Ind'I / Auto-A / LL			6	μA
t <sub>CDR</sub> <sup>[8]</sup>	Chip Deselect to Data Retention Time		0			ns
t <sub>R</sub> <sup>[9]</sup>	Operation Recovery Time		t <sub>RC</sub>			ns

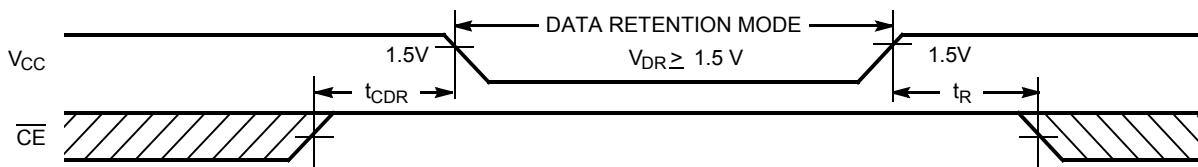
**Data Retention Waveform**

**Notes:**

- Tested initially and after any design or process changes that may affect these parameters.
- Full Device AC operation requires linear V<sub>CC</sub> ramp from V<sub>DR</sub> to V<sub>CC(min)</sub> ≥ 100 μs or stable at V<sub>CC(min)</sub> ≥ 100 μs.

**Switching Characteristics** (Over the Operating Range)<sup>[10]</sup>

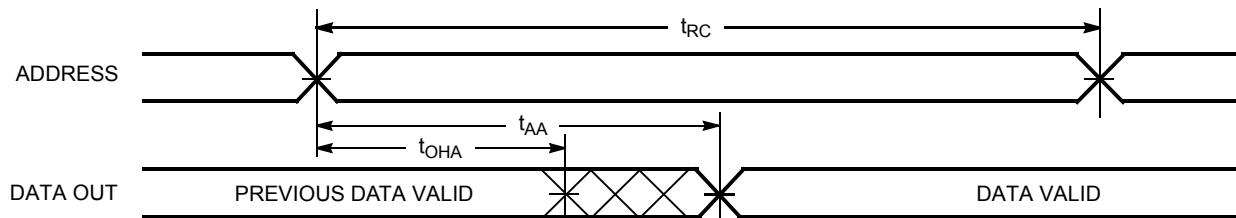
Parameter	Description	55 ns		70 ns		Unit
		Min	Max	Min	Max	
<b>Read Cycle</b>						
$t_{RC}$	Read Cycle Time	55		70		ns
$t_{AA}$	Address to Data Valid		55		70	ns
$t_{OHA}$	Data Hold from Address Change	10		10		ns
$t_{ACE}$	$\overline{CE}$ LOW to Data Valid		55		70	ns
$t_{DOE}$	$\overline{OE}$ LOW to Data Valid		25		35	ns
$t_{LZOE}$	$\overline{OE}$ LOW to Low Z <sup>[11]</sup>	5		5		ns
$t_{HZOE}$	$\overline{OE}$ HIGH to High Z <sup>[11,12]</sup>		20		25	ns
$t_{LZCE}$	$\overline{CE}$ LOW to Low Z <sup>[11]</sup>	10		10		ns
$t_{HZCE}$	$\overline{CE}$ HIGH to High Z <sup>[11, 12]</sup>		20		25	ns
$t_{PU}$	$\overline{CE}$ LOW to Power-up	0		0		ns
$t_{PD}$	$\overline{CE}$ HIGH to Power-up		55		70	ns
<b>Write Cycle<sup>[13]</sup></b>						
$t_{WC}$	Write Cycle Time	55		70		ns
$t_{SCE}$	$\overline{CE}$ LOW to Write End	40		45		ns
$t_{AW}$	Address Set-up to Write End	40		45		ns
$t_{HA}$	Address Hold from Write End	0		0		ns
$t_{SA}$	Address Set-up to Write Start	0		0		ns
$t_{PWE}$	$\overline{WE}$ Pulse Width	40		45		ns
$t_{SD}$	Data Set-up to Write End	25		30		ns
$t_{HD}$	Data Hold from Write End	0		0		ns
$t_{HZWE}$	$\overline{WE}$ LOW to High Z <sup>[11, 12]</sup>		20		25	ns
$t_{LZWE}$	$\overline{WE}$ HIGH to Low Z <sup>[11]</sup>	10		10		ns

**Switching Waveforms**
**Read Cycle No. 1 (Address Transition Controlled)<sup>[14, 15]</sup>**

**Notes:**

- Test Conditions for all parameters other than three-state parameters assume signal transition time of 3 ns or less (1 V/ns), timing reference levels of  $V_{CC(typ)}/2$ , input pulse levels of 0 to  $V_{CC(typ)}$ , and output loading of the specified  $I_{OL}/I_{OH}$  as shown in the "AC Test Loads and Waveforms" on page 4.
- At any given temperature and voltage condition,  $t_{HZCE}$  is less than  $t_{LZCE}$ ,  $t_{HZOE}$  is less than  $t_{LZOE}$ , and  $t_{HZWE}$  is less than  $t_{LZWE}$  for any given device.
- $t_{HZOE}$ ,  $t_{HZCE}$ , and  $t_{HZWE}$  transitions are measured when the output enter a high impedance state.
- The internal write time of the memory is defined by the overlap of  $\overline{WE}$ ,  $\overline{CE} = V_{IL}$ . All signals must be ACTIVE to initiate a write and any of these signals can terminate a write by going INACTIVE. The data input set-up and hold timing should be referenced to the edge of the signal that terminates the write.
- Device is continuously selected.  $\overline{OE}$ ,  $\overline{CE} = V_{IL}$ .
- $\overline{WE}$  is HIGH for read cycle.

**Switching Waveforms** (continued)

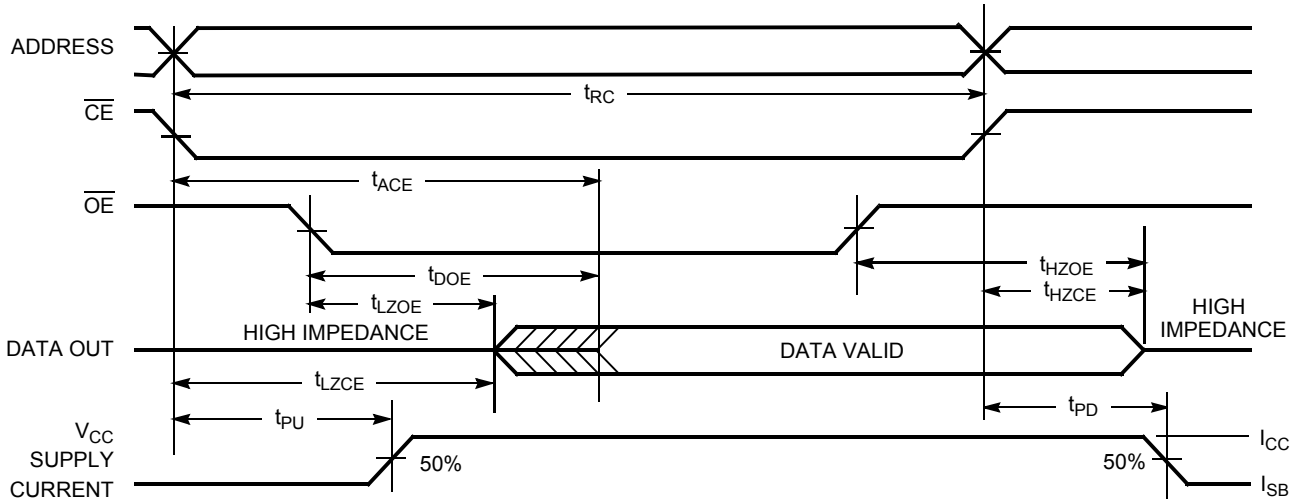
**Read Cycle No. 2 ( $\overline{OE}$  Controlled)**<sup>[15, 16]</sup>



**Write Cycle No. 1 ( $\overline{WE}$  Controlled)**<sup>[17, 18]</sup>

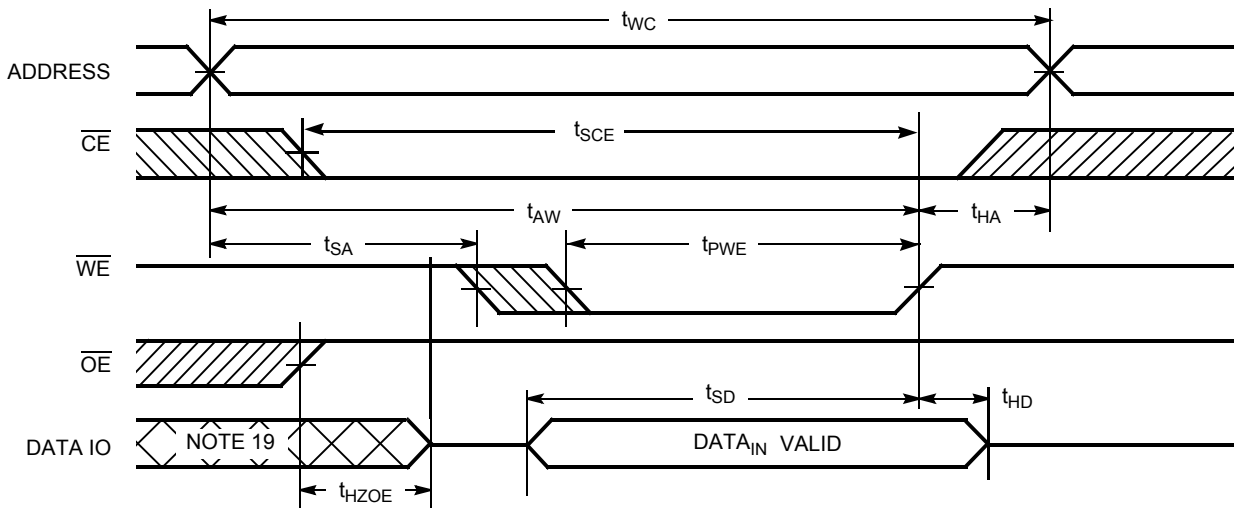

**Notes:**

- 16. Address valid prior to or coincident with  $\overline{CE}$  transition LOW.
- 17. Data IO is high impedance if  $\overline{OE} = V_{IH}$ .
- 18. If  $\overline{CE}$  goes HIGH simultaneously with  $\overline{WE}$  HIGH, the output remains in high-impedance state.
- 19. During this period, the IOs are in output state and input signals should not be applied.

**Switching Waveforms** (continued)

**Write Cycle No. 2 ( $\overline{\text{CE}}$  Controlled)<sup>[17, 18]</sup>**

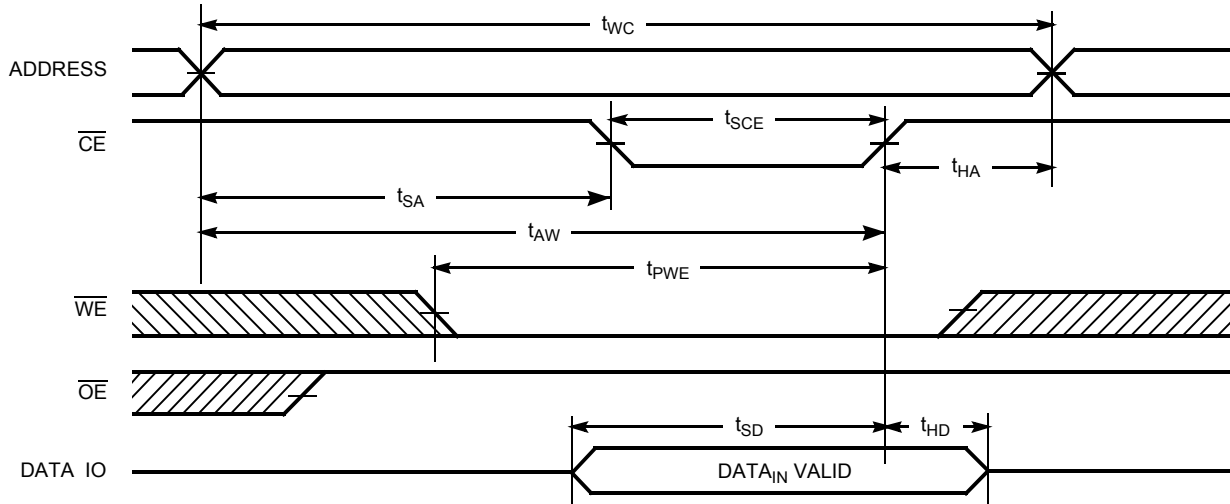

**Write Cycle No. 3 ( $\overline{\text{WE}}$  Controlled,  $\overline{\text{OE}}$  LOW)<sup>[18]</sup>**

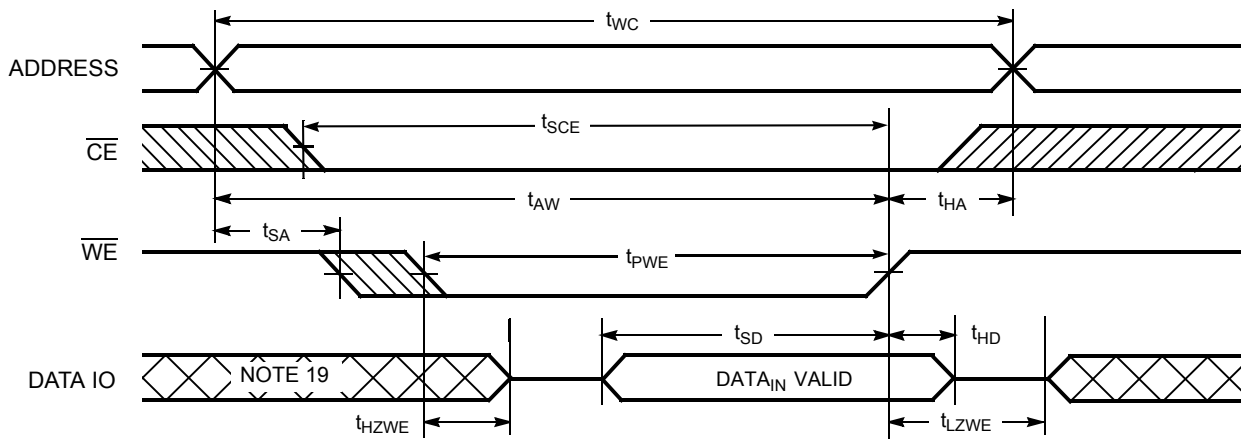

**Truth Table**

$\overline{\text{CE}}$	$\overline{\text{WE}}$	$\overline{\text{OE}}$	Inputs/Outputs	Mode	Power
H	X	X	High Z	Deselect/Power-down	Standby ( $I_{SB}$ )
L	H	L	Data Out ( $\text{IO}_0\text{-IO}_7$ )	Read	Active ( $I_{CC}$ )
L	H	H	High Z	Output Disabled	Active ( $I_{CC}$ )
L	L	X	Data in ( $\text{IO}_0\text{-IO}_7$ )	Write	Active ( $I_{CC}$ )

**Ordering Information**

Speed (ns)	Ordering Code	Package Diagram	Package Type	Operating Range
55	CY62148DV30LL-55BVI	51-85149	36-ball VFBGA (6 × 8 × 1 mm)	Industrial
	CY62148DV30LL-55BVXI		36-ball VFBGA (6 × 8 × 1 mm) (Pb-free)	
	CY62148DV30L-55ZSXI	51-85095	32-pin TSOP II (Pb-free)	
	CY62148DV30LL-55ZSXI			
	CY62148DV30LL-55SXI	51-85081	32-pin SOIC (Pb-free)	
70	CY62148DV30LL-70ZSXI	51-85095	32-pin TSOP II (Pb-free)	Industrial
	CY62148DV30LL-70ZSXA	51-85095	32-pin TSOP II (Pb-free)	Automotive-A

Contact your local Cypress sales representative for availability of these parts

**Package Diagrams**

**Figure 1. 36-ball VFBGA (6 x 8 x 1 mm), 51-85149**

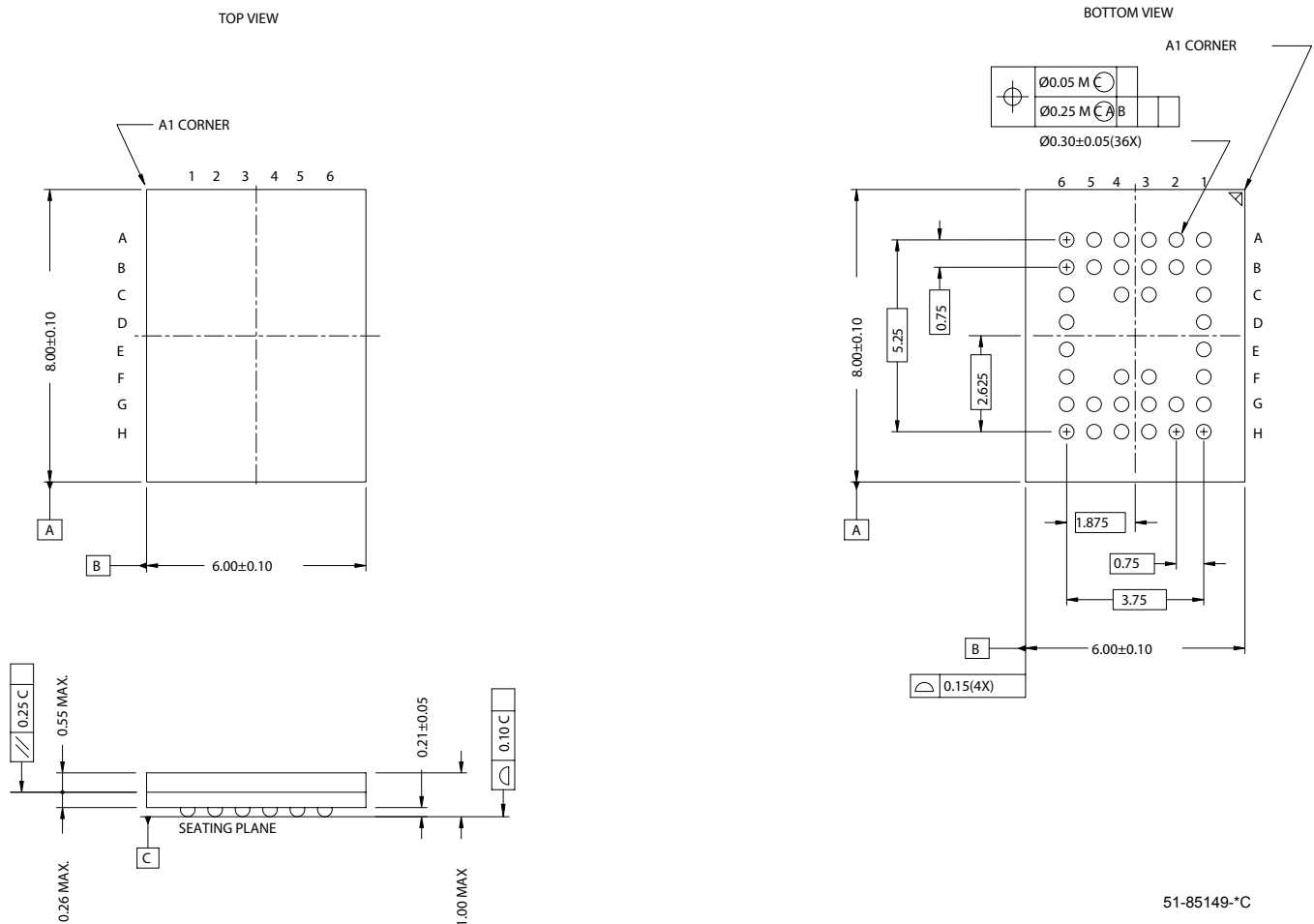



Package Diagrams (continued)

Figure 2. 32-pin TSOP II, 51-85095

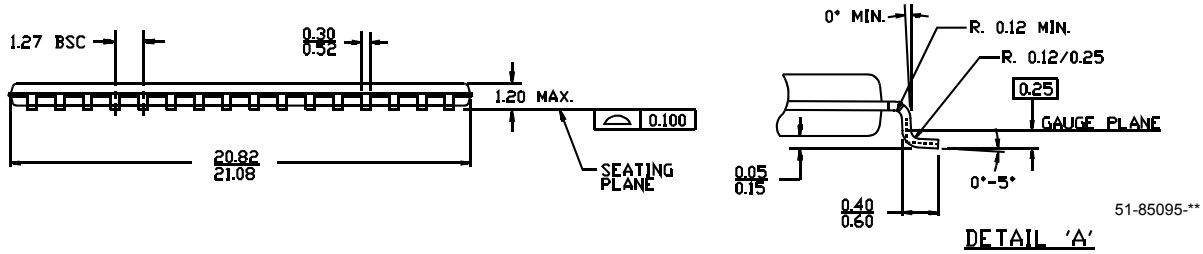
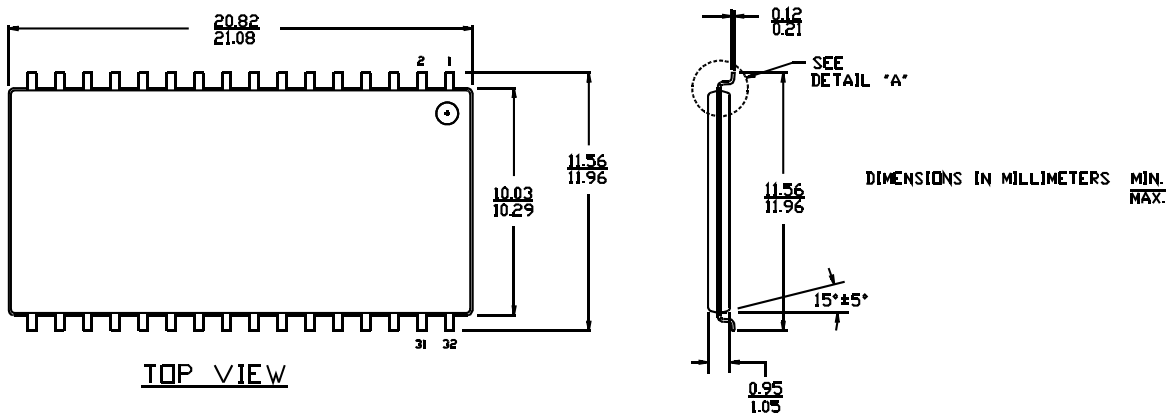
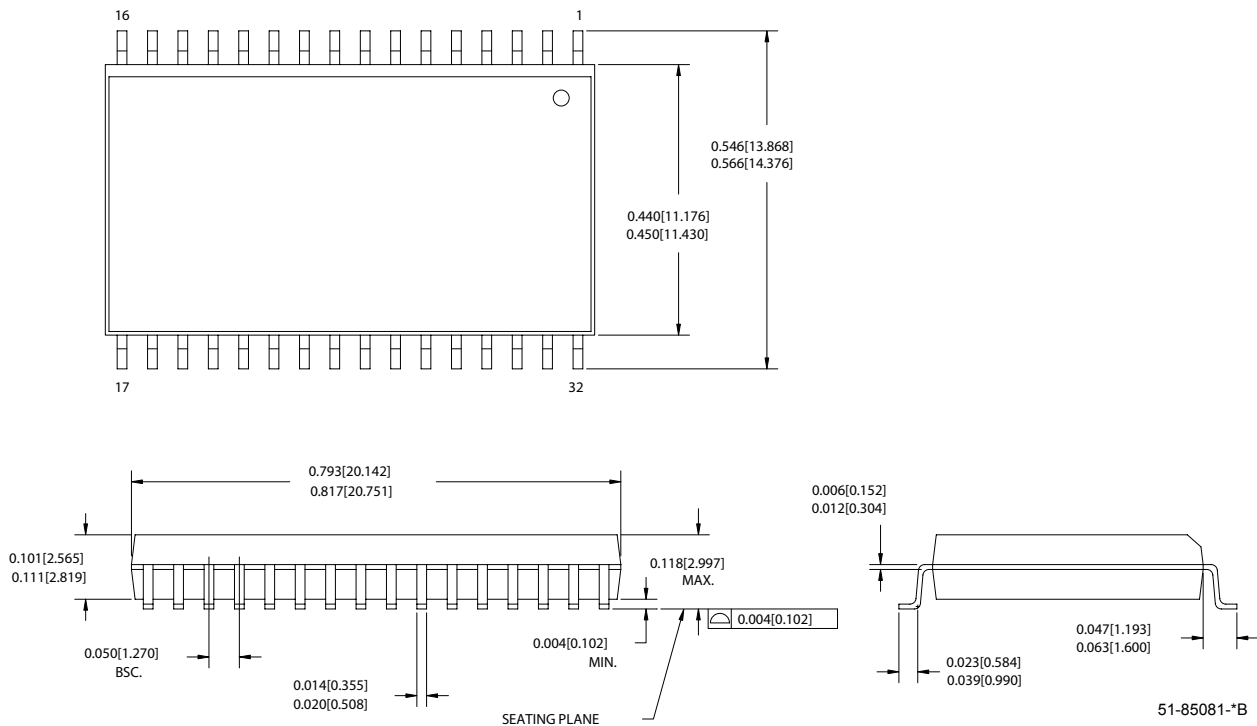

Figure 3. 32-pin (450 MIL) Molded SOIC, 51-85081



MoBL is a registered trademark, and More Battery Life is a trademark, of Cypress Semiconductor. All product and company names mentioned in this document may be the trademarks of their respective holders.

**Document History Page**

Document Title: CY62148DV30, 4-Mbit (512K x 8) MoBL <sup>®</sup> Static RAM				
Document Number: 38-05341				
REV.	ECN NO.	Issue Date	Orig. of Change	Description of Change
**	127480	06/17/03	HRT	Created new data sheet
*A	131041	01/23/04	CBD	Changed from Advance to Preliminary
*B	222180	See ECN	AJU	Changed from Preliminary to Final Added 70 ns speed bin Modified footnote #6 and #12 Removed MAX value for V <sub>DR</sub> on "Data Retention Characteristics" table Modified input and output capacitance values Added Pb-free ordering information Removed 32-pin STSOP package
*C	498575	See ECN	NXR	Added Automotive-A Operating Range Removed SOIC package from Product Offering Updated Ordering Information Table
*D	729917	See ECN	VKN	Added SOIC package and its related information Updated Ordering Information Table